

**INSTRUCTIONS FOR USE
SINGLE WAY OXYGEN MULTIPLE FLOW SELECTOR
TWO WAY OXYGEN MULTIPLE FLOW SELECTOR
FOUR WAY OXYGEN MULTIPLE FLOW SELECTOR**



	PAGE
1. SYMBOLS	2
2. INTENDED USE OF DEVICE	2
3. TECHNICAL DESCRIPTION	2
4. WARNINGS	4
5. INSTRUCTIONS FOR USE	4
6. CLEANING AND DISINFECTION	5
7. INSPECTION AND USER CHECKS	5
8. MAINTENANCE	6
9. ACCESSORIES AND SPARE PARTS	6
10. PERFORMANCE	6
11. SERIAL NUMBERS	6
12. INTENDED LIFE	7
13. APPLICABLE STANDARDS	7
14. MANUFACTURER AND EC REPRESENTATIVE DETAILS	8















READ THESE INSTRUCTIONS PRIOR TO USING THIS EQUIPMENT

A COPY OF THESE INSTRUCTIONS CAN BE FOUND ON OUR WEBSITE (WEB ADDRESS STATED ON THE BACK PAGE OF THIS BOOKLET)

CHECK THERE IS NO DAMAGE TO THE DEVICE PRIOR TO OPENING AND USING. IF ANY DEFECTS FOUND PLEASE NOTIFY THE MANUFACTURER OR AUTHORISED REPRESENTATIVE.

1. SYMBOLS

	Indicates a potentially hazardous situation which could result in injury to the user or others, if not avoided.
	Read these instructions before using the equipment
	Do not use any form of grease or oil
	No Smoking
	Do not use this device near any source of ignition
	Product part number
	Medical Device
	Authorised representative.
	Serial Number
	Date of manufacture and country of manufacturer.
	Manufactured by
	Next Maintenance or Service Due date

2. INTENDED USE OF DEVICE

The Meditech Flow Selectors are used to deliver variable flow rates of gas to a patient who requires medical gas therapy. The patient will be breathing on his own but may have a need for support to supply oxygen enriched air to increase blood oxygen levels. The flow outlet will be either a 'fir tree connector' for use with standard oxygen tubing fitted to a therapy mask, or canula or a threaded outlet for use with a humidifier. Flow outlets can be switched between different rates as per section 10 on performance, for the different types of models available. Units can be supplied with a single outlet or two or four independently controllable outlets. Multiple outlet units should be connected to a regulator having sufficient dynamic pressure at the total flow envisaged.

3. TECHNICAL DESCRIPTION

This Oxygen Flow Selector is designed for use with oxygen supplies at a nominal pressure of 4 bar, from a cylinder fitted with a suitable 4 bar pressure regulator or from a 4-bar wall outlet. It consists of a brass or aluminium body with a suitable inlet connector (meeting the medical oxygen gas connection

standard specified) and an outlet connection, a barbed fir-tree style connector to allow push fit of an oxygen tube, or a threaded connector 9/16"-18 for attaching a humidifier or other accessory. The inlet to the flow selector body is fitted with a filter. The principle of operation is that the oxygen passes through one of a number of selectable orifices, the user selecting the flow rate shown in litres per minute in the Therapy outlet flow display window. The selected flow is then available from the therapy outlet connection.

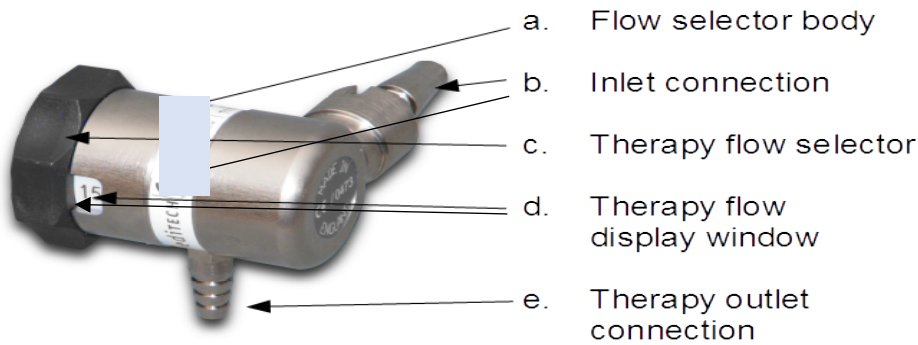
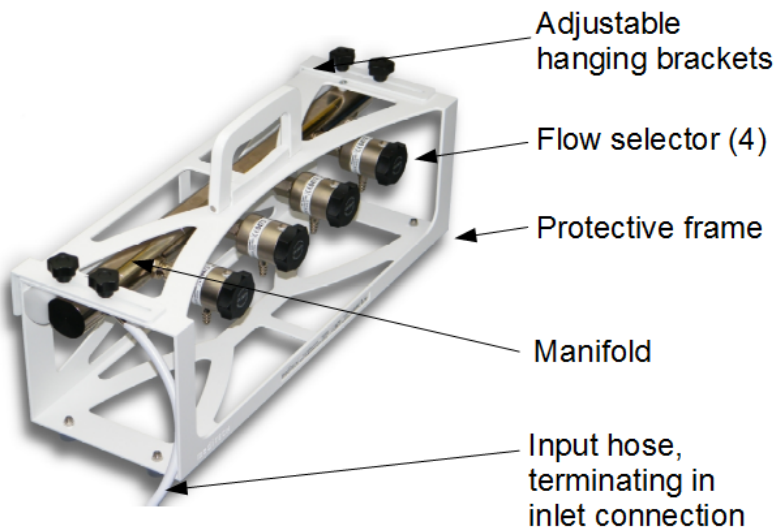

Figure A. Single Oxygen Therapy flow selector.



On multiple flow selectors the additional flow selectors are connected by means of a manifold. The oxygen inlet is connected directly to the manifold or via a flexible supply hose connection. Each individual selector operates as described above.

Figure B. Four Way Oxygen Therapy Flow Selector.

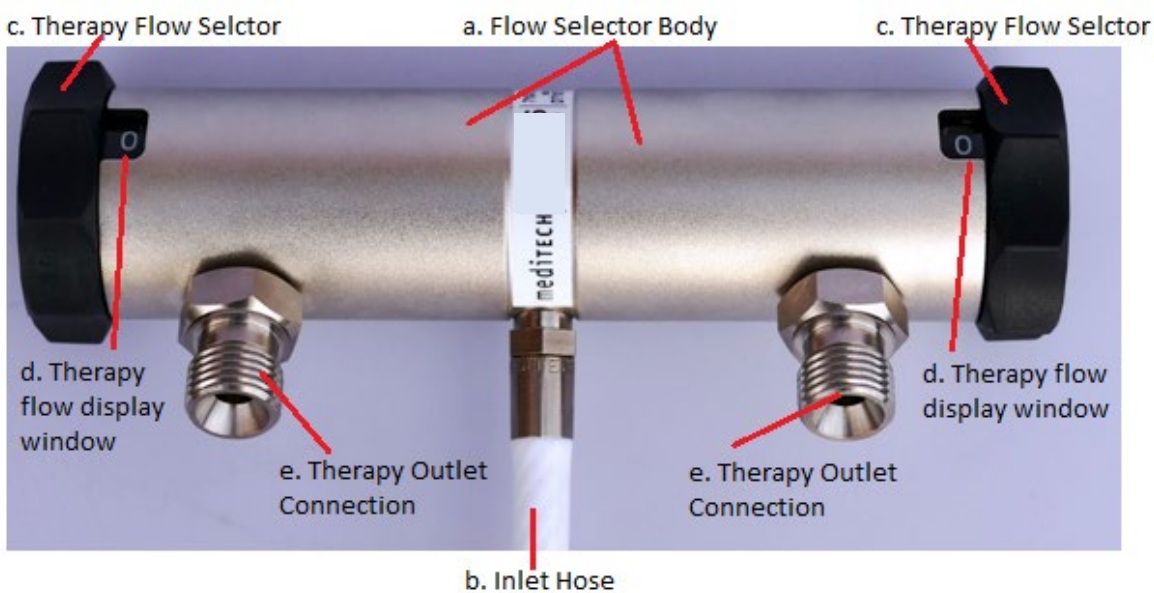

Figure C. Dual Oxygen Therapy Flow Selector



4. WARNINGS!



THIS FLOW SELECTOR IS TO BE USED BY ADEQUATELY TRAINED PERSONNEL ONLY.



4.1 The user should ensure that no grease, oil, or other contaminants encounter the cylinder, valve, regulator, gauge(s), flow selector or connections.

4.2 Do not use this device near any source of ignition e.g., naked flame, electrically powered heaters, cigarettes etc.



4.3 Always open the cylinder valve **slowly** to minimise pressure shocks.

4.4 The connectors fitted to the Flow Selector are designed specifically for this device. If replacements are needed, they must be approved parts supplied by B.N.O.S. Meditech Ltd.

4.5 The Flow Selector must not be disassembled when it is under pressure, as serious injury could result.

4.6 The Flow Selector must be set at the defined settings shown on the dial. It must not be set between adjacent settings, as this may result in no flow from the outlet.

4.7 The accuracy of the Flow selector will be affected if the input pressure is varied from the nominal value shown in the Performance section of this document.

4.8 Note that increasing output flow is obtained from the Flow selector if the control is turned clockwise.

4.9 The Flow Selector device does not indicate that a flow is occurring. The User must check that oxygen is flowing to the patient by another means.

4.10 Attention is drawn to the accuracies stated in the Performance section of this document.

4.11 Do not attempt to modify the fittings to suit other gases or fitting systems other than what is stated on the labelling.

5.0 INSTRUCTIONS FOR USE

5.1. USE WITH AN OXYGEN CYLINDER FITTED WITH A PRESSURE REGULATOR

5.1.1 Check your Oxygen Cylinder to ensure that it is correctly labelled as medical oxygen. Ensure that the Pressure Regulator is correctly attached to the Oxygen Cylinder, in accordance with its instructions. Check that the Cylinder and Regulator combination is not leaking by briefly opening the Cylinder Valve slowly. Close the Cylinder Valve.

5.1.2 Ensure the Flow Selector is set to '0'. Insert male probe of the Flow Selector (b) into the female outlet of the Oxygen Regulator by pushing firmly into the orifice. It may be necessary to lock the connector in place using a nut, depending on the type of connection in use. For outlets and probes to BS 5682:2015, it is necessary only to ensure that it clicks home and locks automatically. Other fittings are available for specific markets, and these will have different connections.

5.1.3 Open the Cylinder Valve **slowly**. If a leak of gas is heard, turn off the Cylinder Valve and check all connections. Check the therapy selector (or selectors) is turned to 0.

5.1.4 To attach equipment to the therapy outlet (e), connect with elastomeric tubing. When connected select the required flow rate by rotating the therapy outlet flow selector (c) and observing the flow rate selected in the therapy outlet flow display window (d). Note that flow rate increases as the control is turned clockwise.

5.1.5 After use the cylinder valve should be turned off. With emergency equipment it is possible to leave the regulator assembled to the cylinder valve and the Flow Selector attached to the regulator outlet. This enables the user to quickly turn on the oxygen supply to the equipment when required in an emergency.

5.1.6 The therapy outlet flow selector (c) should always be left in the off position ("0" indicated in the therapy outlet flow selector window (d)) when the therapy outlet is not in use. This prevents oxygen escaping un-noticed from the outlet (e) when the oxygen bottle is turned on.

5.2. USE WITH AN OXYGEN WALL OUTLET

5.2.1 Check your Wall Outlet to ensure that it is correctly labelled as medical oxygen. Ensure the therapy outlet flow selector (c) is set to '0'. Insert male probe of the Flow Selector (b) into the female wall outlet by pushing firmly into the orifice. It may be necessary to lock the connector in place using a nut,

depending on the type of connection in use. For outlets and probes to BS 5682:2015, it is necessary only to ensure that it clicks home and locks automatically. Other fittings are available for specific markets, and these will have different connections.

- 5.2.2 To attach equipment to the therapy outlet (e), connect with elastomeric tubing. When connected select the required flow rate by rotating the Therapy outlet flow selector (c) and observing the flow rate selected in the Therapy outlet flow display window (d).
- 5.2.3 The therapy outlet flow selector (c) should always be left in the off position ("0" indicated in the therapy outlet flow selector window (e)) when the therapy outlet is not in use. This prevents oxygen escaping un-noticed from the outlet (d). If possible, remove the Flow Selector from the Wall Outlet when it is not in use.

6 CLEANING AND DISINFECTION

- 6.1 Surface cleaning of the Flow Selector should be carried out using soap flakes in solution.
- 6.2 For disinfection purposes a chlorine dioxide-based product (e.g., the Tristel Wipes System) should be used, at a nominal concentration of 0.02% wt/vol. The concentration refers to chlorine dioxide in water. The Flow Selector should be wiped clean only and should not be submerged in any fluids.
- 6.3 After cleaning or disinfection, the Flow Selector should be wiped with clean water to remove any residue and then allowed to dry before returning to use.

NOTE: THIS DEVICE IS NOT SUITABLE FOR AUTOCLAVING.

7 INSPECTION AND USER CHECKS

7.1 INSPECTION

- 7.1.1 The Flow Selector should be inspected for damaged or broken components and contamination after each use.
- 7.1.2 If contaminated, the Flow Selector should be cleaned in accordance with Section 6.
- 7.1.3 If damaged, the Flow Selector should be withdrawn from service and returned to B.N.O.S. Meditech for assessment and repair.

7.2 USER CHECKS (to be carried out before and after cleaning) *Ensure no blockages of the pressure relief valves (E.g., frozen in extreme temperature)*

- 7.2.1 Inspect the Flow Selector for signs of physical damage. Check the oxygen supply hose (if fitted) for splitting or damage and check the input connector is clean and in good condition. If damage has occurred withdraw from service and arrange for repair.
- 7.2.2 Check that the operation of the selector or (selectors on two and four-way units) has distinct stops at all settings but can be operated smoothly between settings without undue force.
- 7.2.3 Plug the Flow Selector into a Wall Outlet or suitable regulator. With the supply to the wall outlet switched on, check for audible leaks when the therapy outlet flow selector (c) is in the off position ("0" indicated in the therapy outlet flow selector window (e)).
- 7.2.4 Check that the operation of the selector has distinct stops at all settings but can be operated smoothly between settings without undue force. Check that the flow increases as the therapy outlet flow selector (c) is operated. Check there is no flow when the selector is returned to 0.
- 7.2.5 Unplug the Flow Selector from the supply if it is not immediately needed. If the Flow Selector fails any of these checks or is very difficult to connect or disconnect, it should be withdrawn from service and returned to B.N.O.S. Meditech Ltd. for assessment and repair.

8 MAINTENANCES

- 8.1** Maintenance on the Flow Selector should be performed on a seven-yearly basis by B.N.O.S. Meditech or engineers certified by B.N.O.S. Meditech. This activity involves dismantling the unit and replacing all internal seals and any components which show significant wear and tear. Oxygen supply hoses (where fitted) require replacement on a five-year interval.
- 8.2** Performance should also be checked on an annual basis, following the maintenance activity noted above, using suitable test equipment. Verify that the flow rates on all settings are within specification at room temperature, using an accurate 4 bar (400 kPa) supply. If required, B.N.O.S. Meditech Ltd. can advise on suitable test equipment.
- 8.3** A leak test should also be performed by applying an oxygen compatible leak test solution to all outlets, fittings, and joints, where applicable.
- 8.4** B.N.O.S. Meditech Ltd. offers training and certification on the service, repair, and preventative maintenance of Meditech products.

9 ACCESSORIES AND SPARE PARTS

No specific accessories or spare parts are listed for the Flow Selector.

10 PERFORMANCES

Temperature ranges: Storage: -40°C to +60°C, Operating: -20°C to +60°C (-4 °F to +140 °F).

Nominal Inlet Pressure: 4 bar (400kPa)

Minimum Inlet Pressure: 3.5 bar (350kPa)

Maximum Inlet Pressure: 4.5 bar (450kPa)

Test Inlet pressure: 10 bar (1000kPa). The unit will remain mechanically sound at this input pressure.

Therapy Outlet Settings: 0-15 lpm flow rates 0, ½, 1, 2, 3, 4, 6, 8, 10, 15 lpm

0-25 lpm flow rates 0, ½, 1, 2, 3, 4, 6, 8, 10, 15 and 25 lpm

0-70 lpm flow rates 0, 10, 20, 30, 35, 40, 50, 55, 60 and 70 lpm

The figures represent the nominal flow rate from the outlet. These figures are subject to a tolerance of ±20% of each stated value for flows greater than 1.5 lpm and ± 30% of each stated value for flows for flows 1.5 lpm or less.

Variation of outlet flow when inlet pressure is varied from Minimum to Maximum. There will be less than 12.5% variation from the indicated value with a variation in input pressure from the Minimum value stated above to the Maximum value stated above (i.e., ± 0.5 bar(50kPa)).

Variation of outlet flow when Outlet Resistance is varied up to 40 cm H₂O: 2%

Typical variation of outlet flow when temperature is varied from 0°C to +40°C: 5%

For units having multiple flow selector outlets, the flow from one outlet shall not vary by more than 2.5% when all the other outlets are adjusted to their maximum and minimum values.

11 SERIAL NUMBER

SN

The Serial No. is to be found on the “barrel” label of the Flow Selector or, for multiple units, on a label on the frame. It consists of four sections the first letters expressing the general type of device, followed by numbers for the month and year of manufacture and lastly a set of up to five numbers, representing the ‘number’ of the unit and differentiating units built in the same month. For a unit with multiple outlets, each outlet unit will carry the main serial number of the overall unit, with a letter suffix (e.g., A, B, C or D).

Example for Single Oxygen Therapy Flow Selector:

T	03	21	12345
Flow Selector	Month of Manufacture	Year of Manufacture	Number of unit

Example for Dual Oxygen Therapy Flow Selector:

DT	03	21	12345
Dual Flow Selector	Month of Manufacture	Year of Manufacture	Number of Unit

Example for Four Way Oxygen Therapy Flow Selector:

MCFM	03	21	12345
Four Way Flow Selector	Month of Manufacture	Year of Manufacture	Number of Unit

12 INTENDED LIFE

This Flow Selector has been designed to give many years of reliable service. It is manufactured from the finest quality materials with individual components subject to strict quality control tests to ensure high standards under ISO 13485. It is designed to have a product life span of 10 years, excluding abuse to the instrument.

We reserve the right to change design without prior notice.

13 APPLICABLE STANDARDS

B.N.O.S. Meditech Ltd. is an ISO 13485:2016 certified company.

B.N.O.S. Meditech Flow selectors are supplied in conformity under a quality system to meet Medical Devices Directive 93/42/EEC and The Medical Devices Regulations UK MDR 2002 (SI 618) as subsequently amended by the EU Exit Regulations of 2019 (SI 791) and 2020 (SI 1478).

The above conformity routes have been inspected by the Notified Body Ref: CE 2797 being BSI, Say Building, John M. Keynesplein 9, 1066 EP Amsterdam, The Netherlands and for UKCA by UK Approved Body UKCA 0086 being BSI, Kitemark Court, Davy Avenue, Milton Keynes, MK5 8PP

Flow selectors are classified as Class IIa Medical Devices.

The following National & International Standards apply to the device:

Standard Number:	Title:
BS EN ISO 15002:2008	Flow-metering devices for connection to terminal units of medical gas pipeline systems.
BS 5682:2015 OR International Fittings (if applicable)	Specification for probes (quick connectors) for use with medical gas pipeline systems
BS EN ISO 15001:2011	Anaesthetic and respiratory equipment. Compatibility with oxygen
BS EN ISO 15223-1:2021	Medical devices – Symbols to be used with medical device labels, labelling and information to be supplied
EN ISO 20417:2021	Medical devices. Information to be supplied by the manufacturer.

It is also certified that the equipment listed above fully complies with all the required mandatory standards and the performance, specifications, standards, and sources agreed and contracted for this order.

IMPORTANT NOTICE

Manufacturer's Warranty is for a period of 7 years and includes parts and labour. It does not include transport costs.

This is under the condition that the device is sent to Meditech for service at the 5-year period.

The responsibility and cost of returning and collecting the unit from the manufacturer or their authorised representative is the owners.

Any disassembly of the device beyond that detailed in this manual will invalidate the warranty and the manufacturers disclaim any liability for products that have undergone unauthorised repair.

COMPANY CONTACT DETAILS

This flow selector is designed and manufactured by:



B.N.O.S. Meditech Ltd.
9 Fifth Avenue, Bluebridge Ind. Est.,
Halstead, Essex CO9 2SZ, England
Tel: +44 (0)1787 479475,
Fax: +44 (0)1787 477747
E-mail: sales@meditech.uk.com
www.meditech.uk.com



EU REPRESENTATIVE:
MEDICAL DEVICE MANAGEMENT LTD
BLOCK B, THE CRESCENT BUILDING
NORTHWOOD, SANTRY
DUBLIN 9, D09 C6X8
IRELAND
Tel: 353 (0) 1893 4143

CE
2797

UK
CA
0086